

EVENTOS

IV Jornadas Patrimonio Bibliográfico

2024



Más allá de los 90-120º



crue

Universidades
Españolas

Red de Bibliotecas
REBIUN

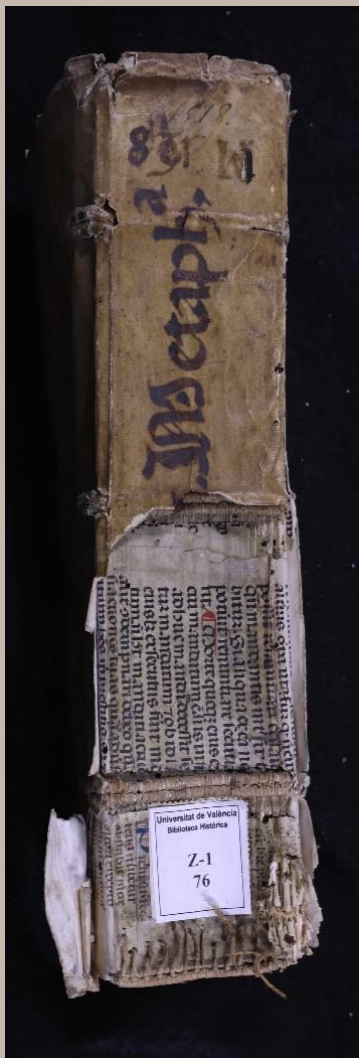

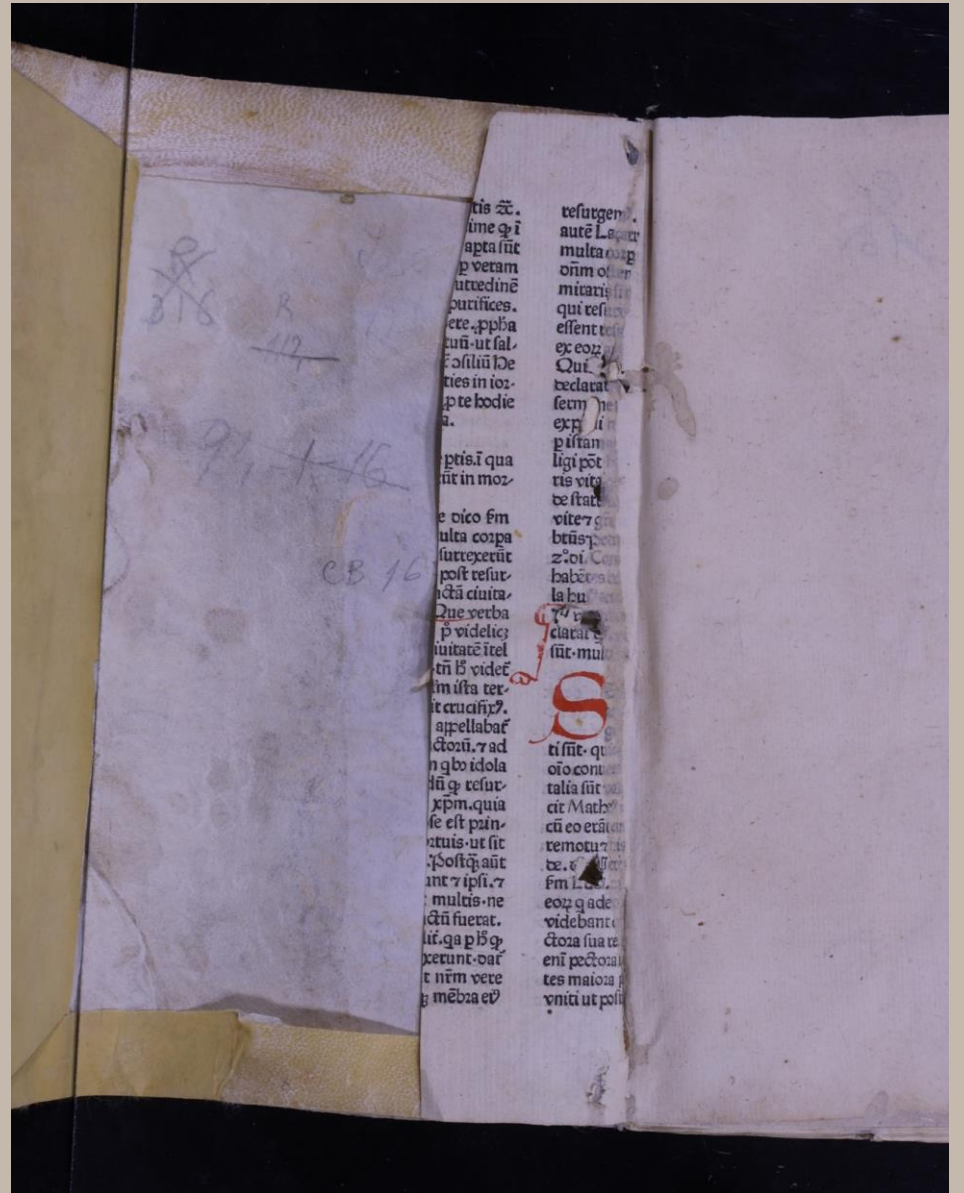
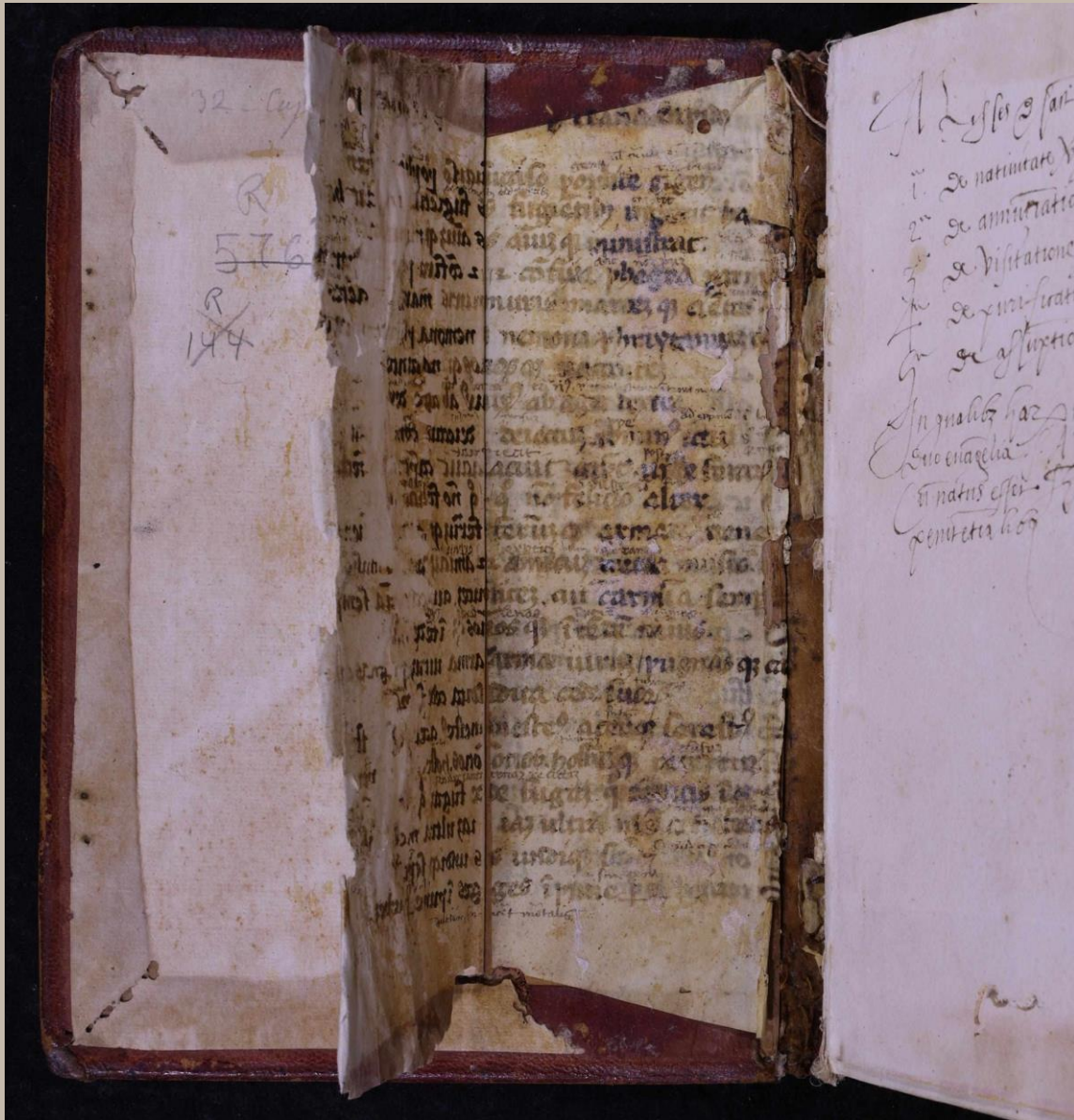

¿Cómo exponemos los fragmenta?

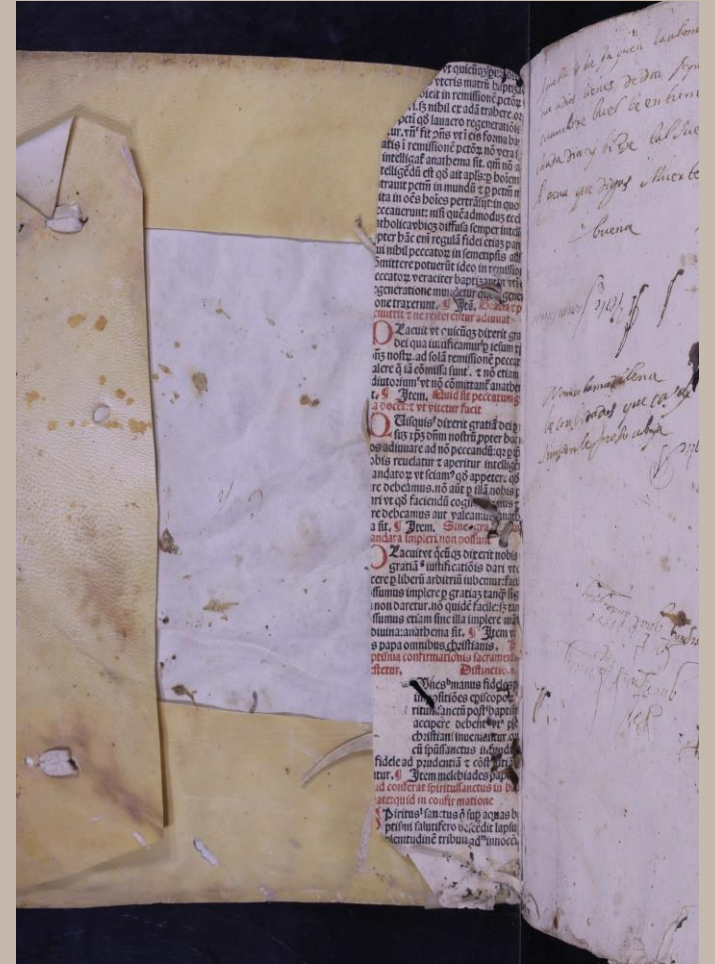
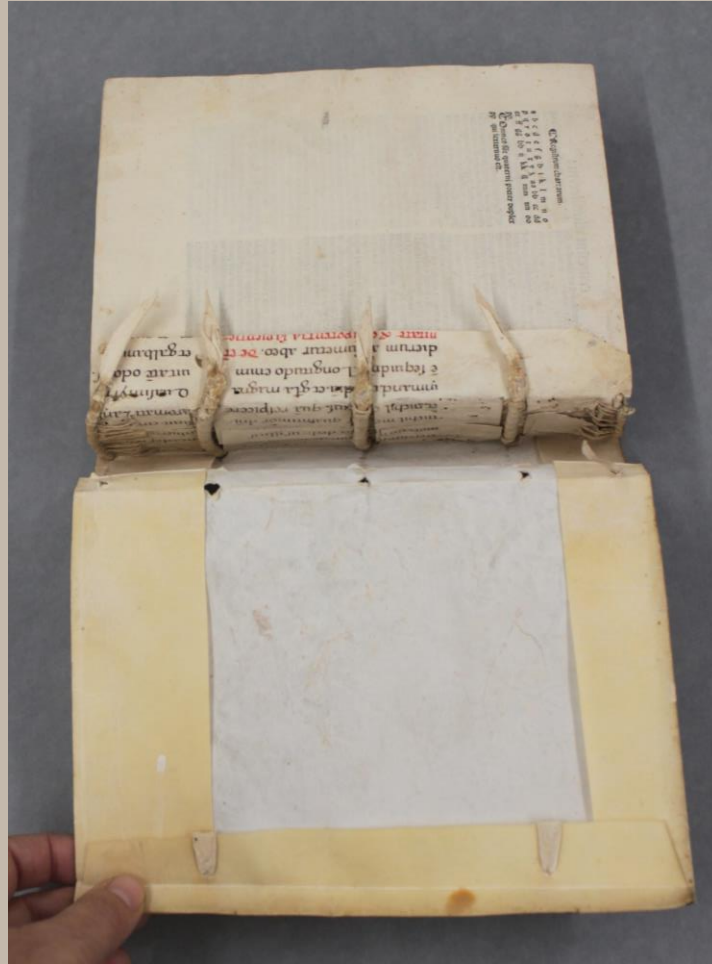
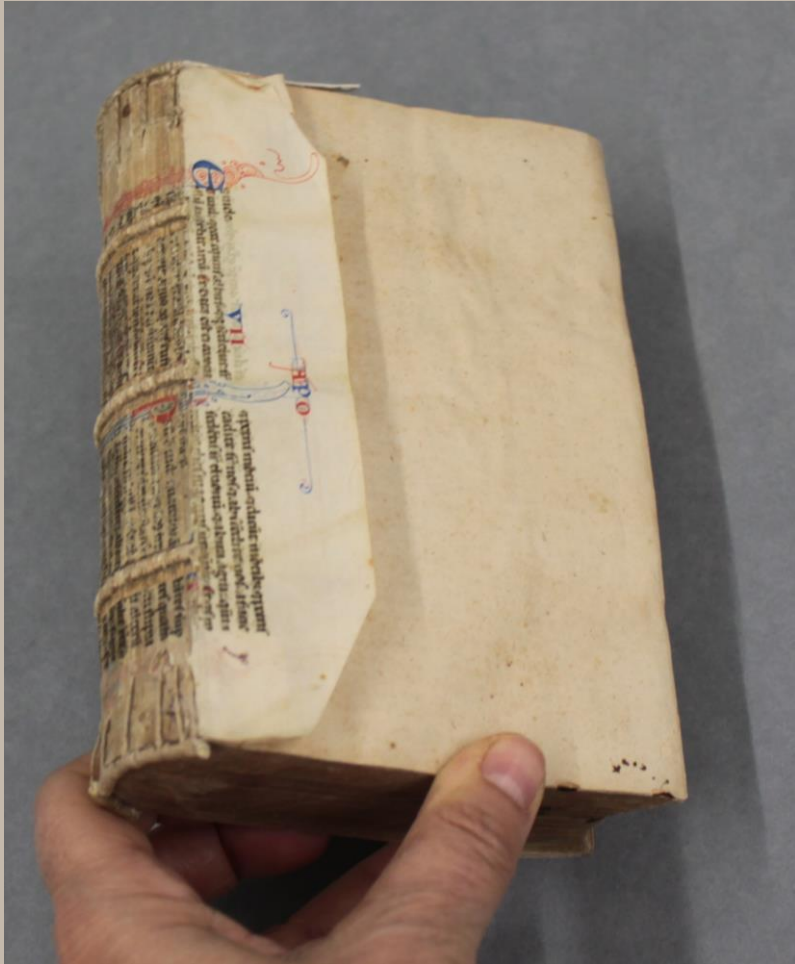



30

31

32



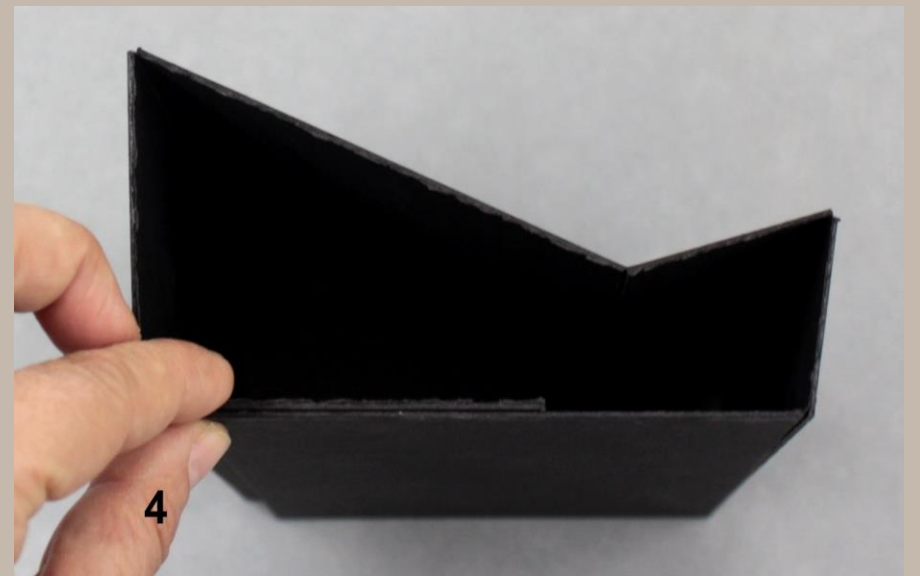
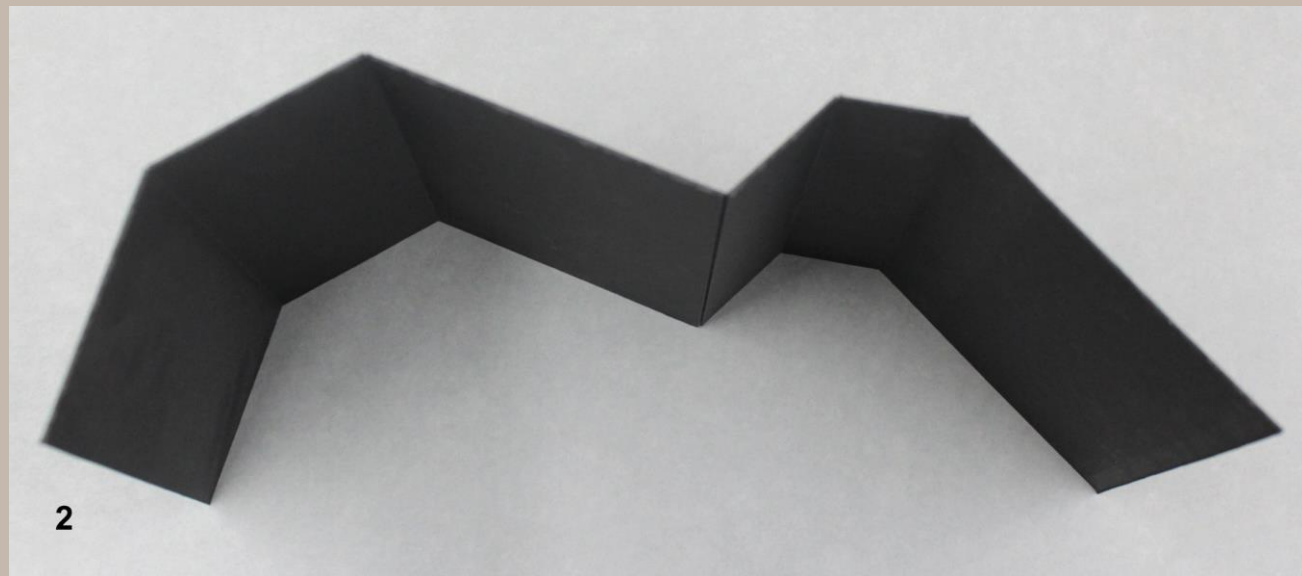
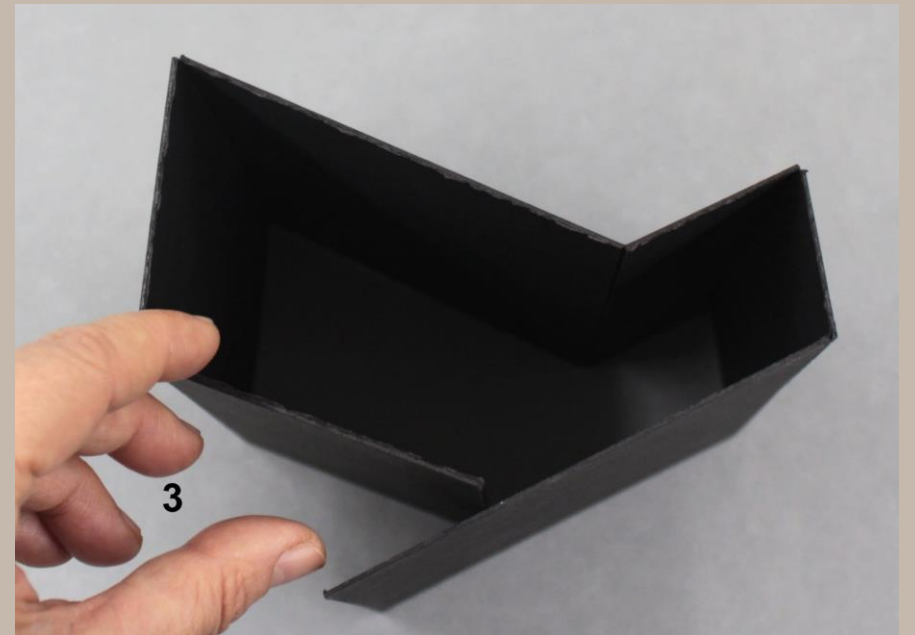
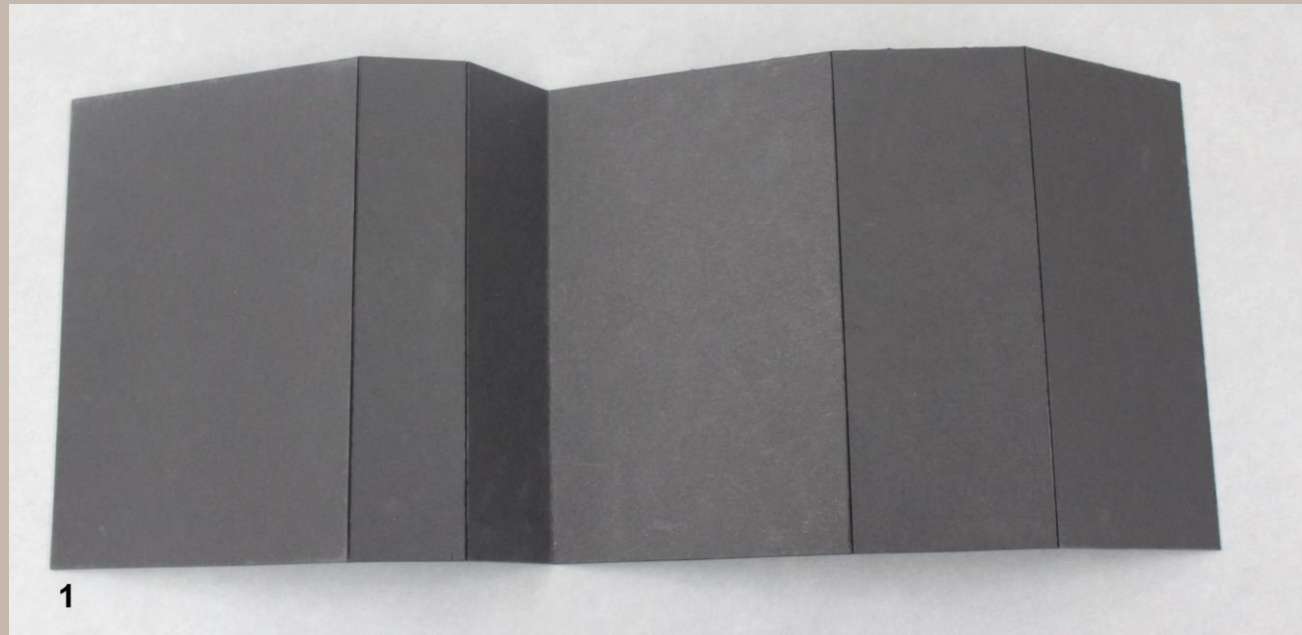

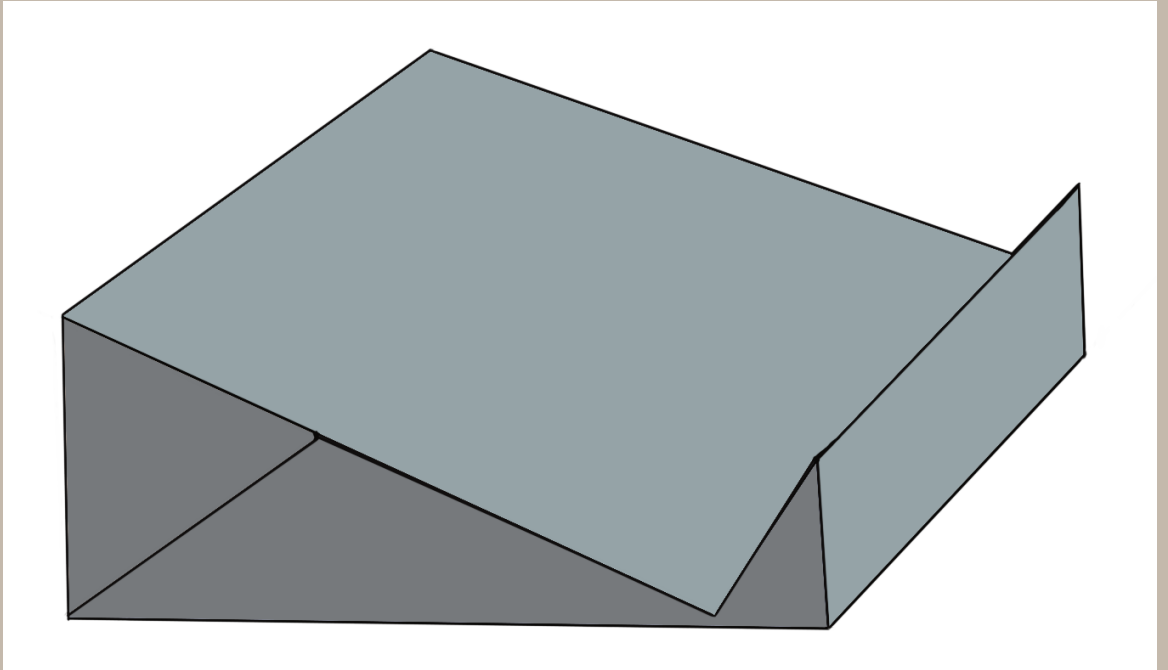
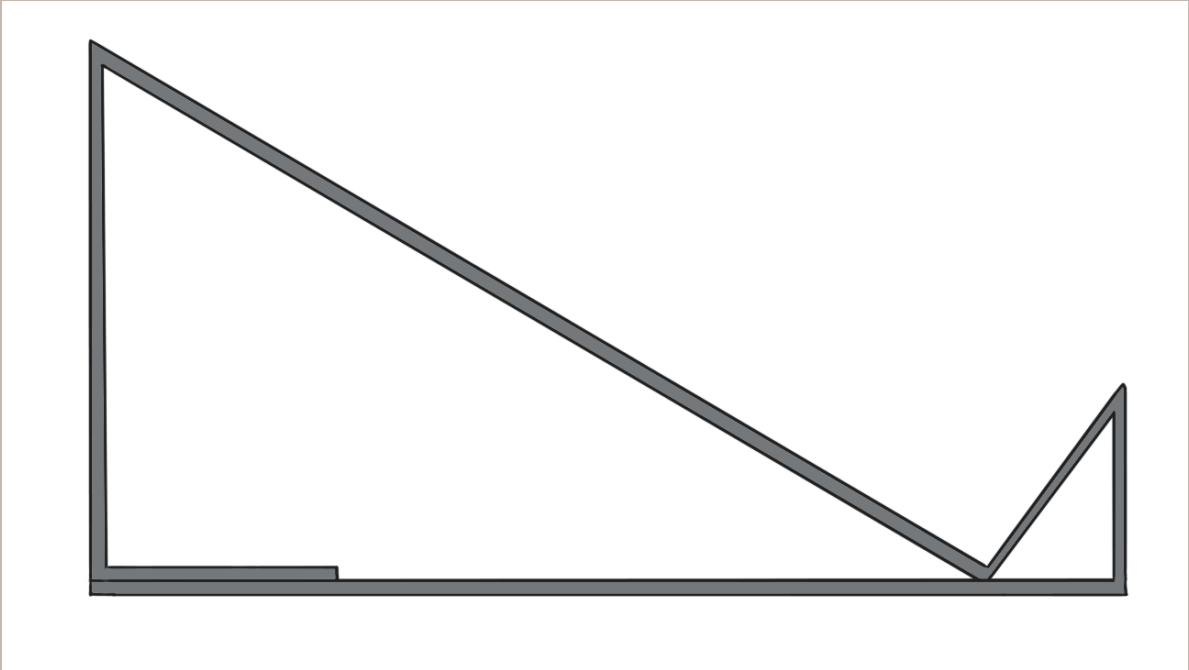



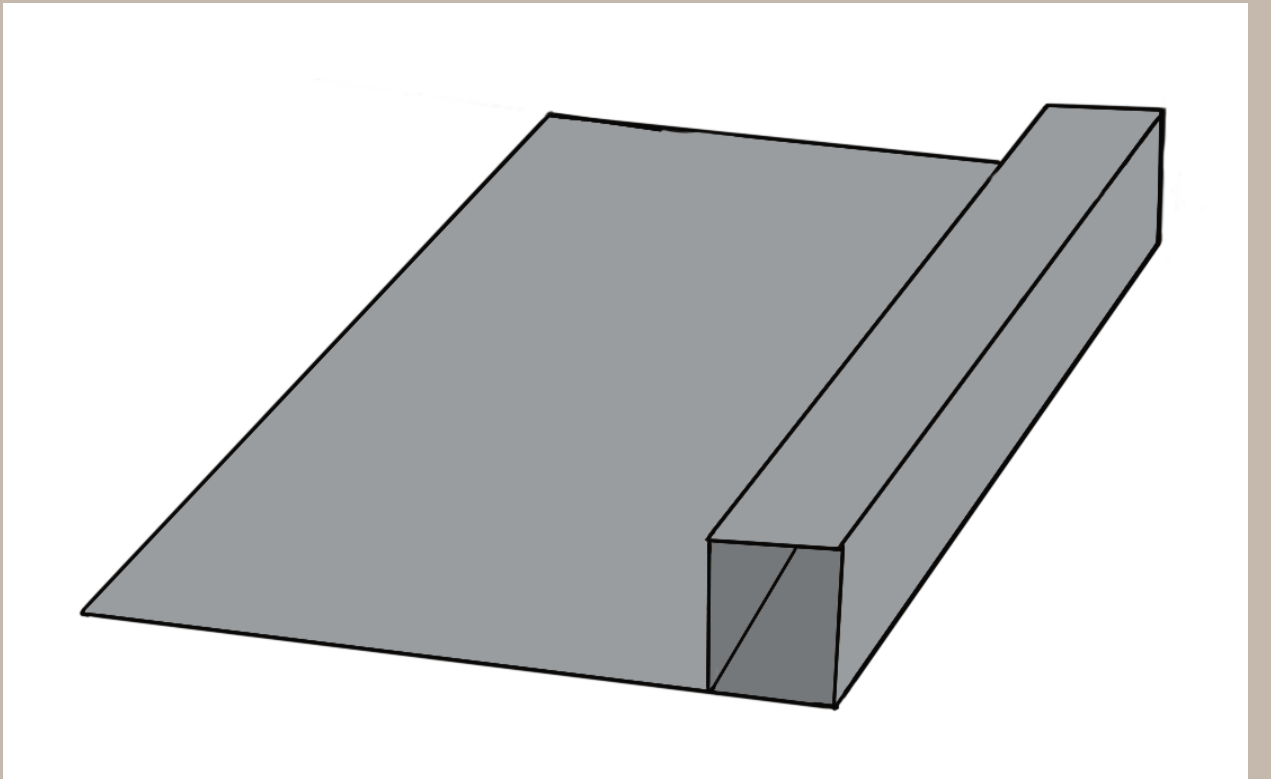



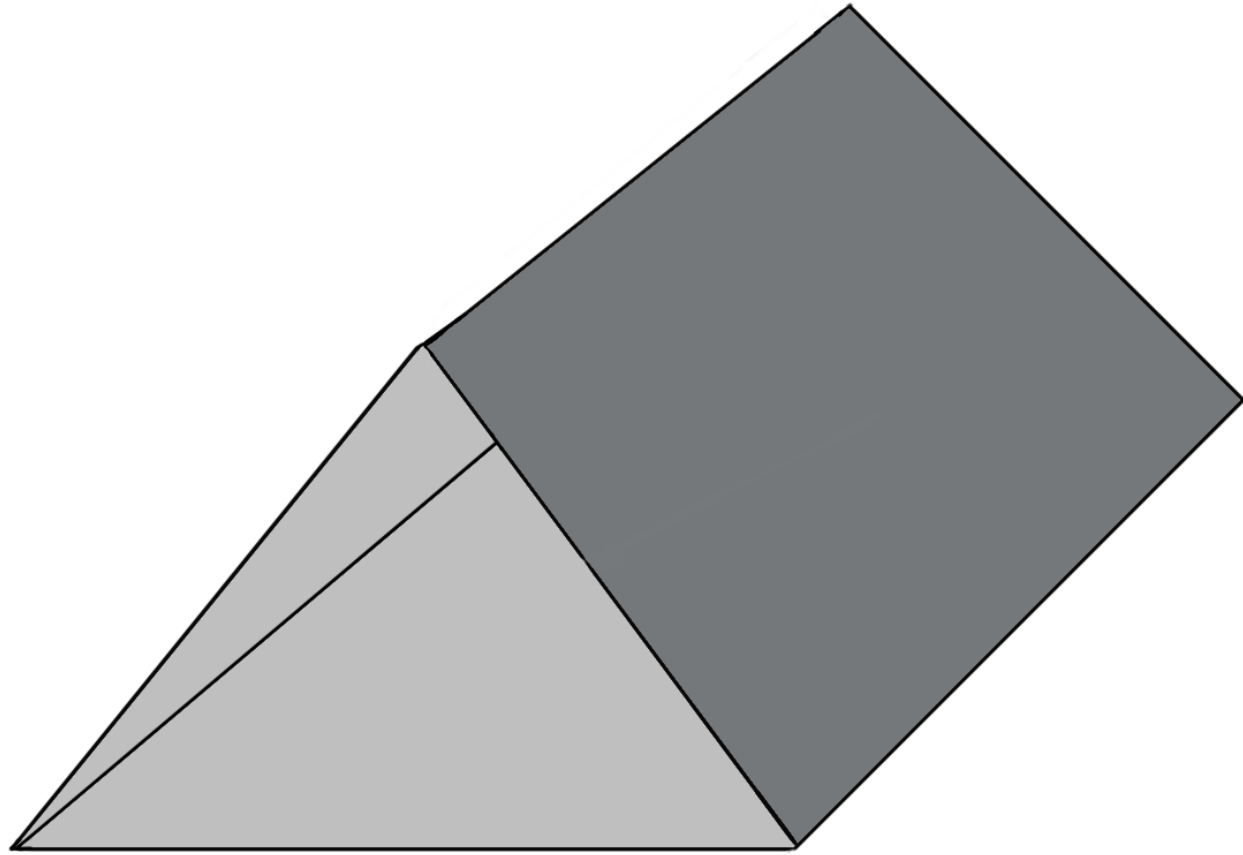

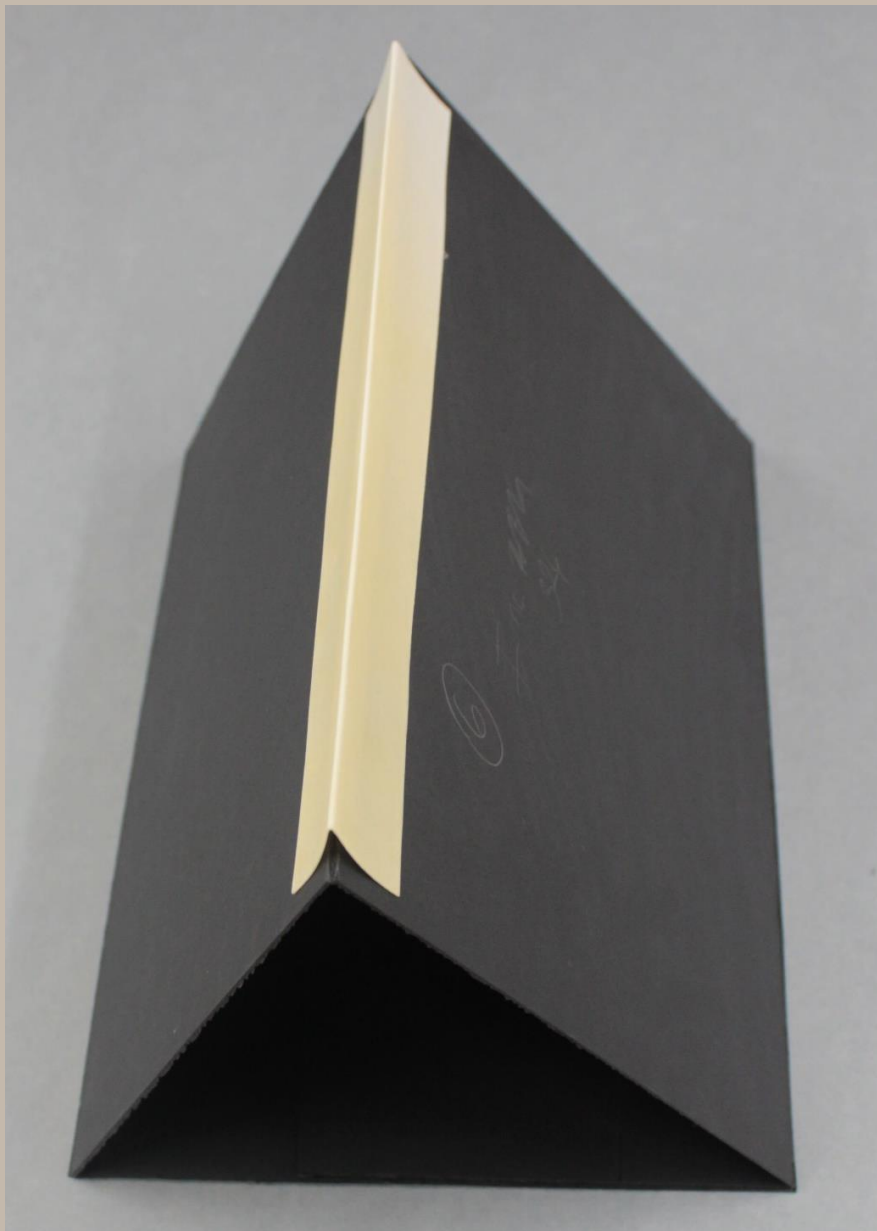

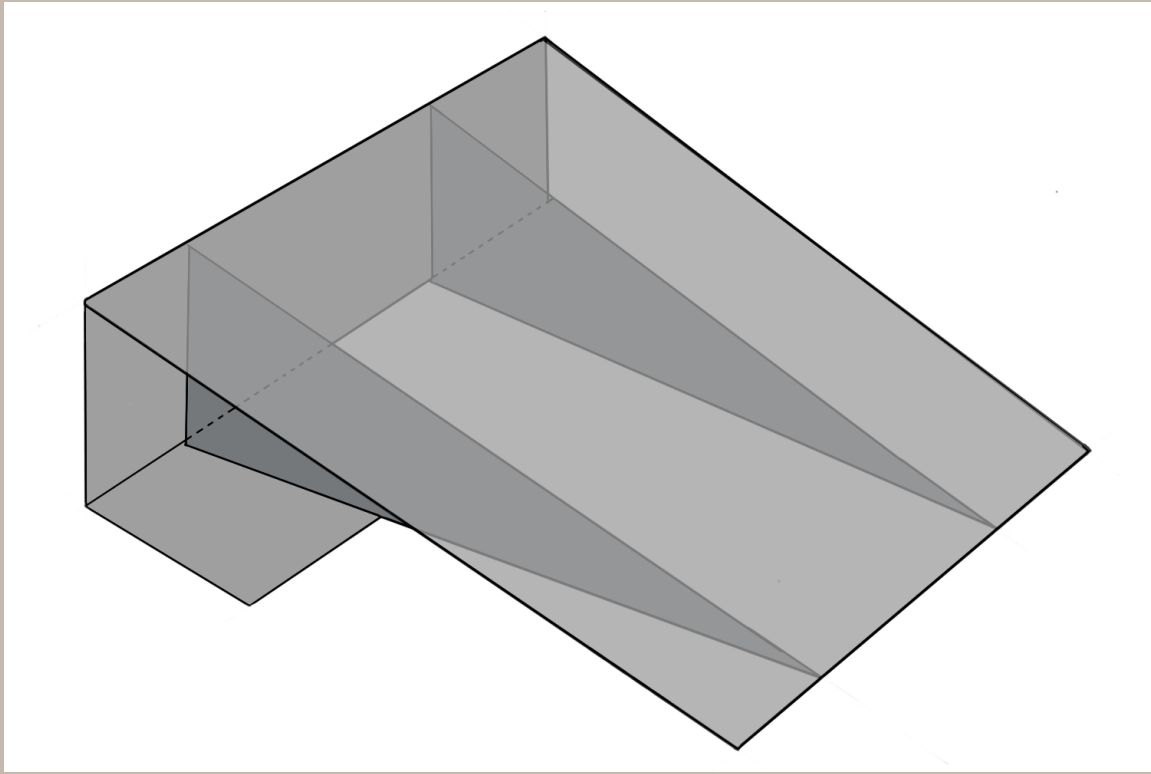

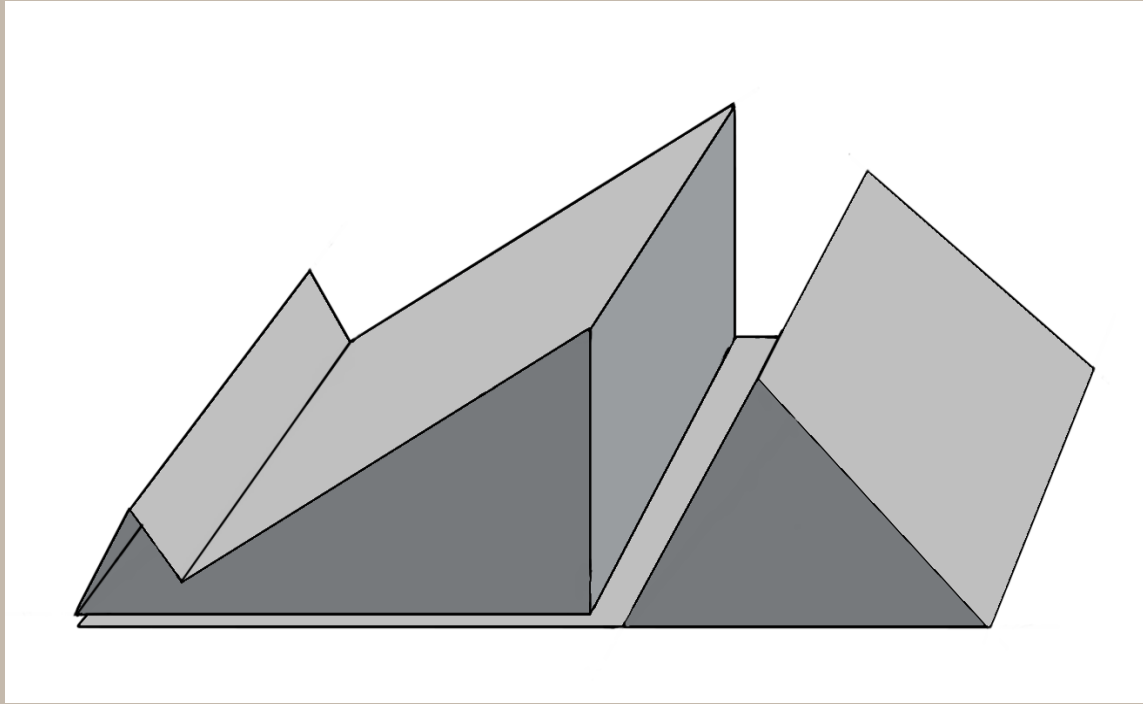



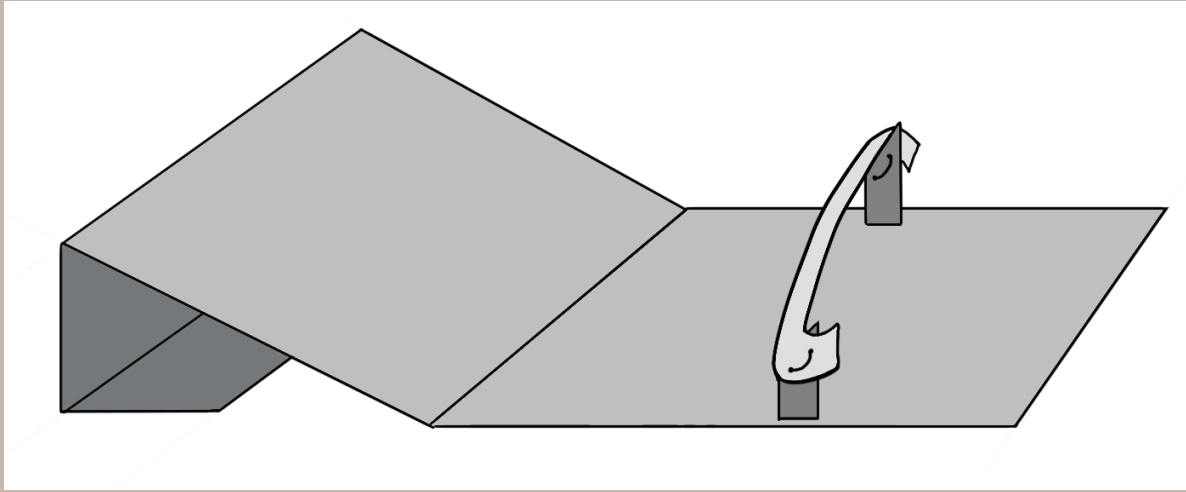

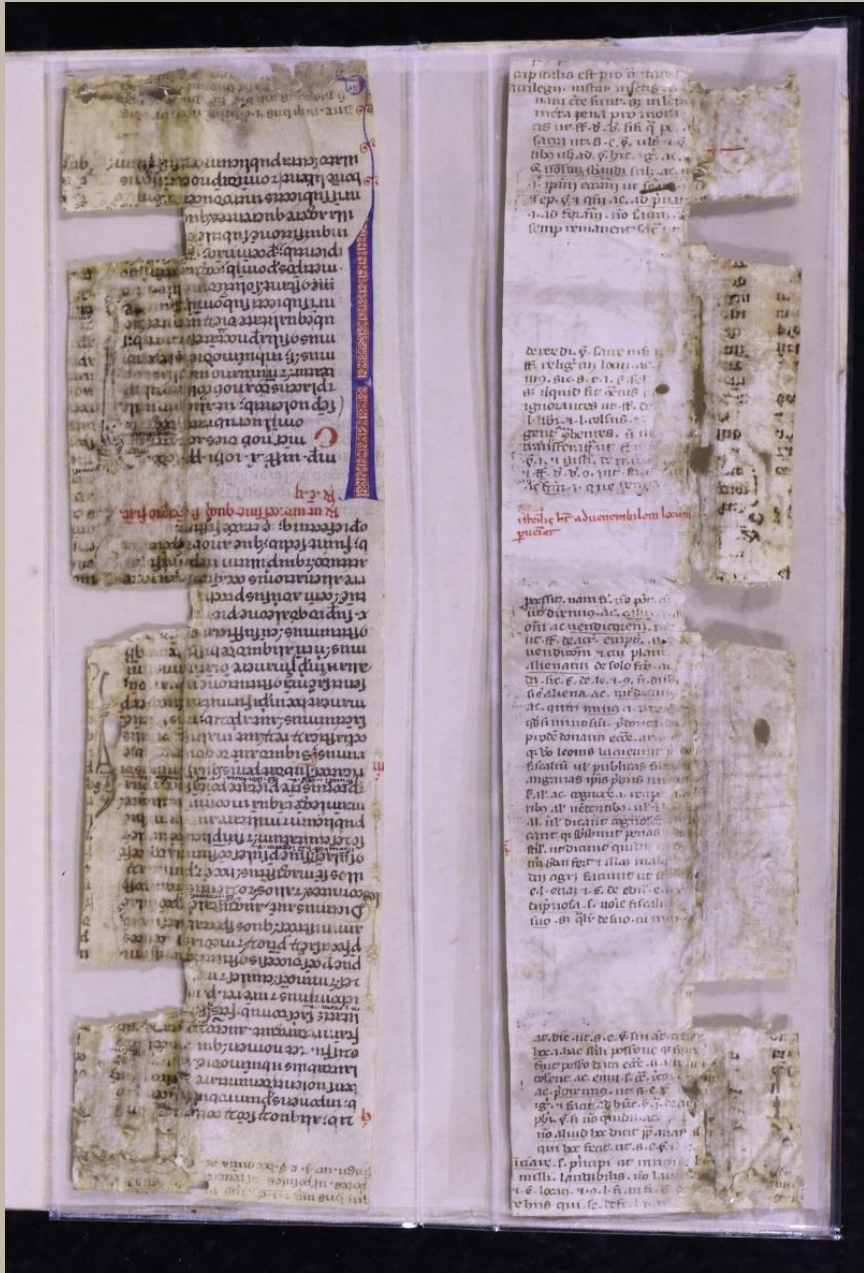

Modificaciones de última hora



Unión de piezas de cartón

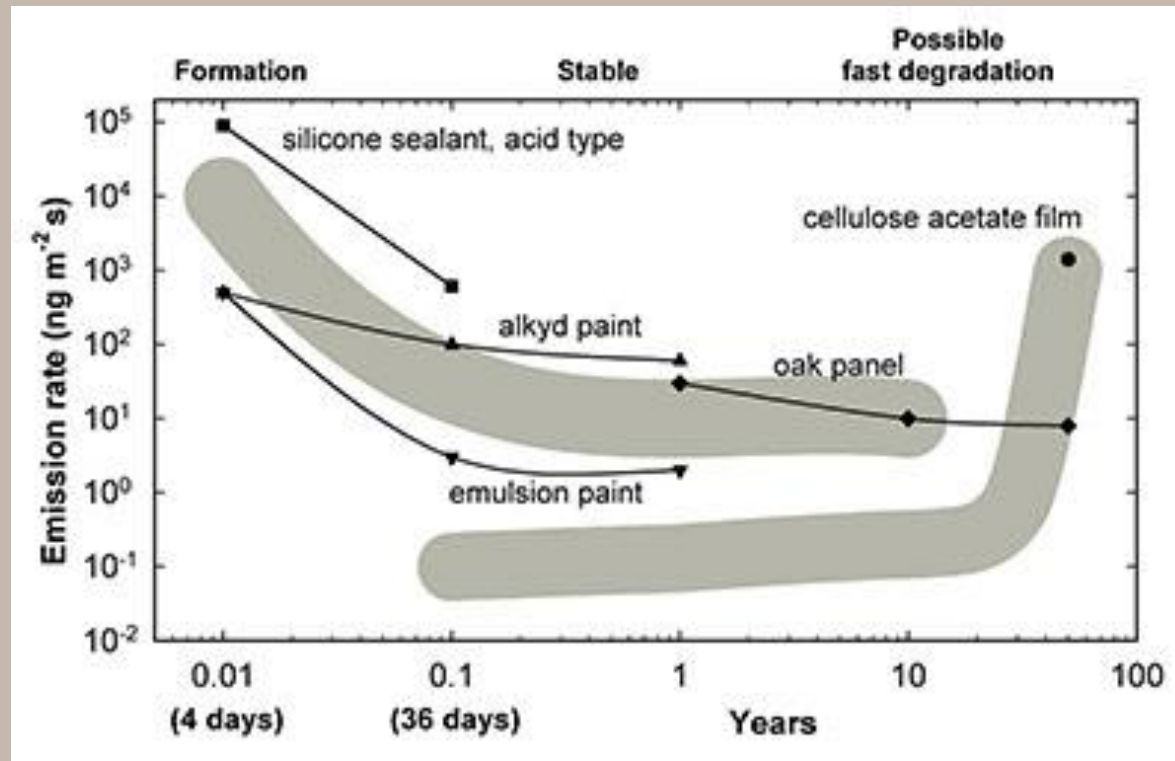

© Government of Canada, Canadian Conservation Institute. CCI 120171-0003
Figure 1. Emisión de ácido acético de productos con el tiempo. Las emisiones de los sellantes de silicona, pinturas alquídicas y emulsiones (acrílicas, vinílicas...) descienden considerablemente tras un mes de ventilación. El acetato de celulosa es inicialmente estable, pero tras 40 años empieza a exhalar gases significativamente.

Unión de piezas de cartón

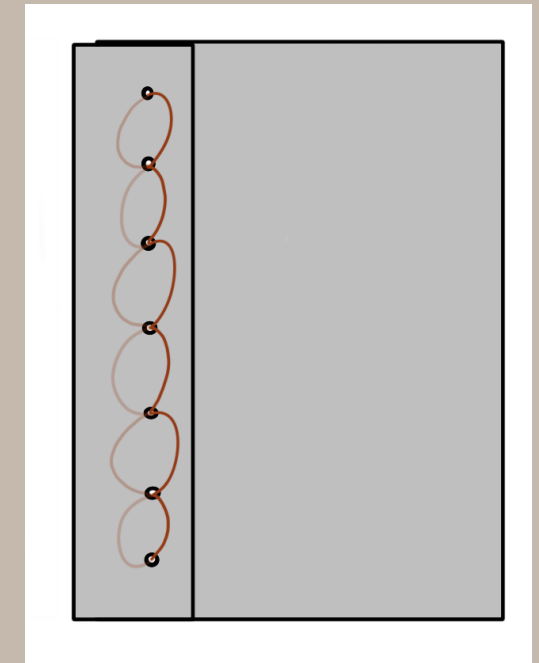
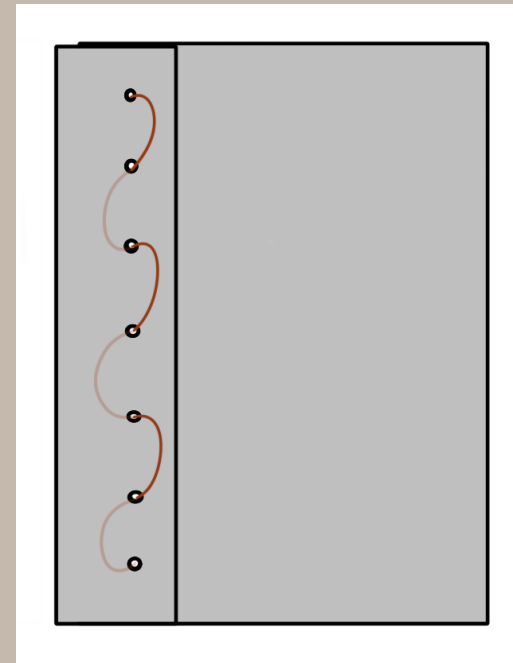
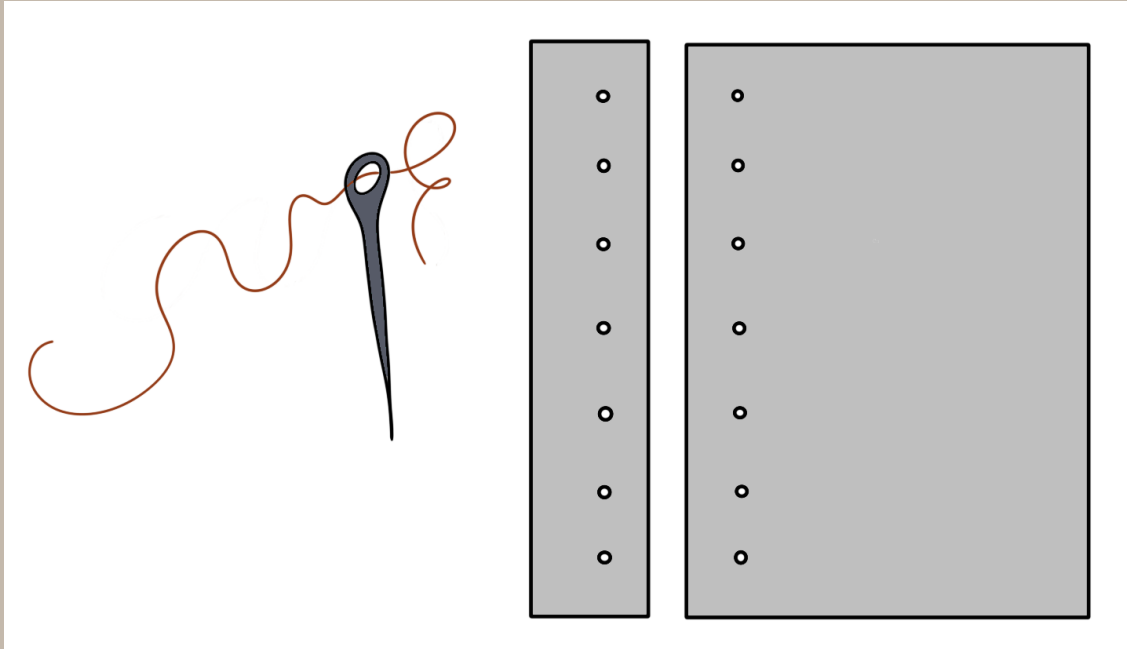

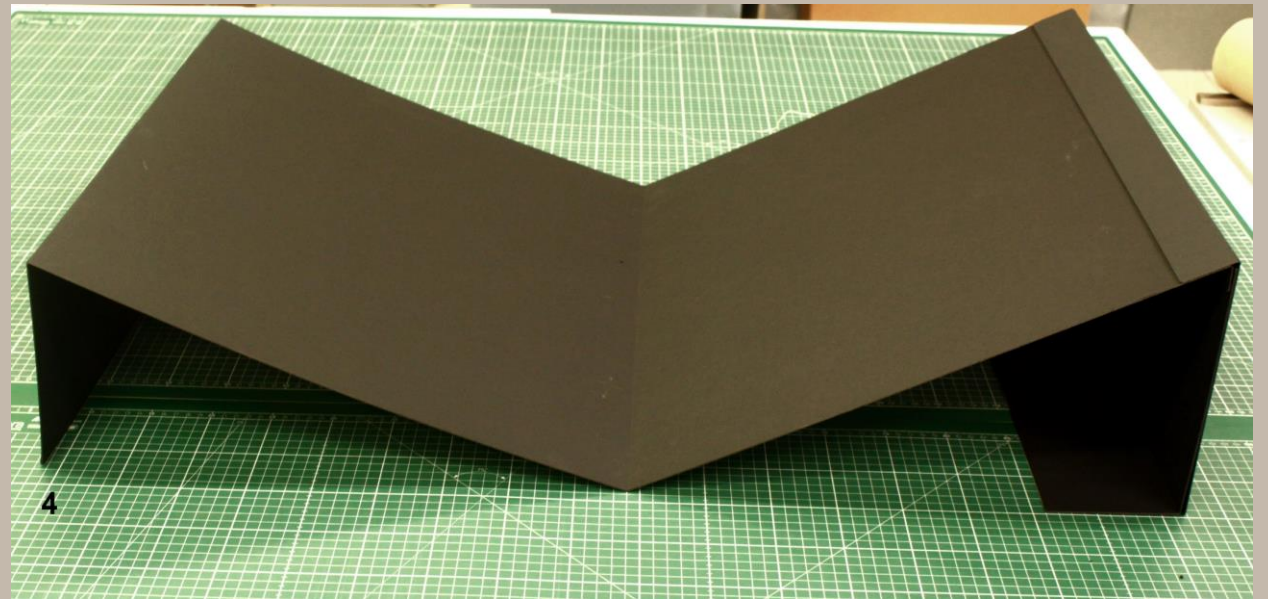
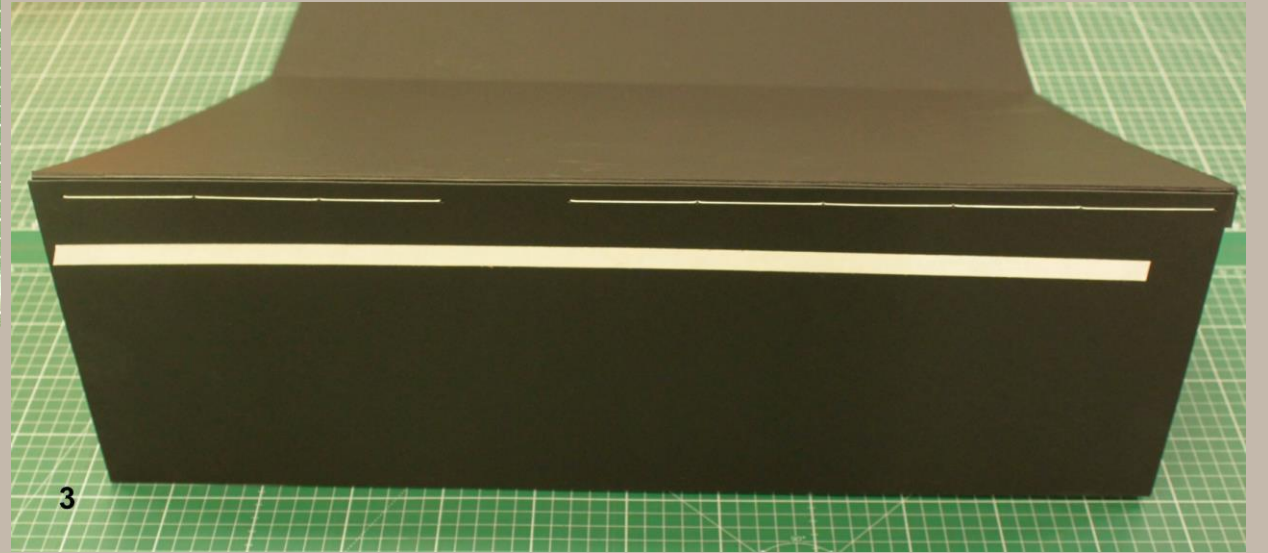
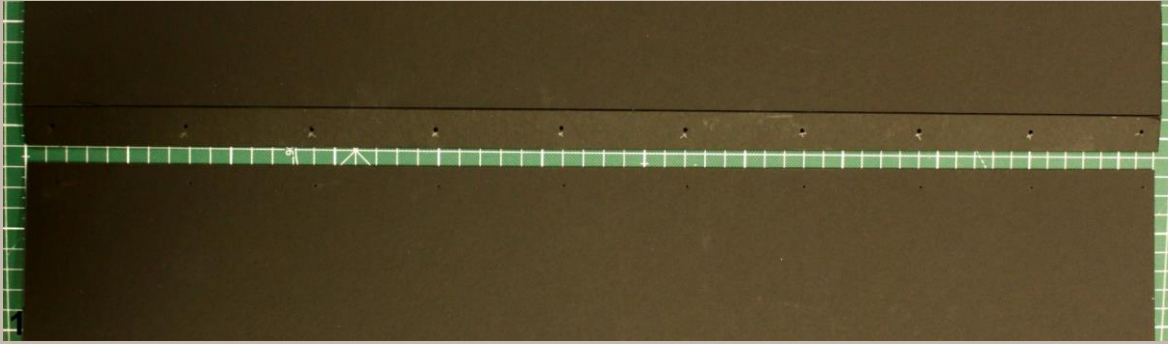

Gracias por su atención



VNIVERSITAT
DE VALÈNCIA

bibliotequèsUV
HISTÒRICA